

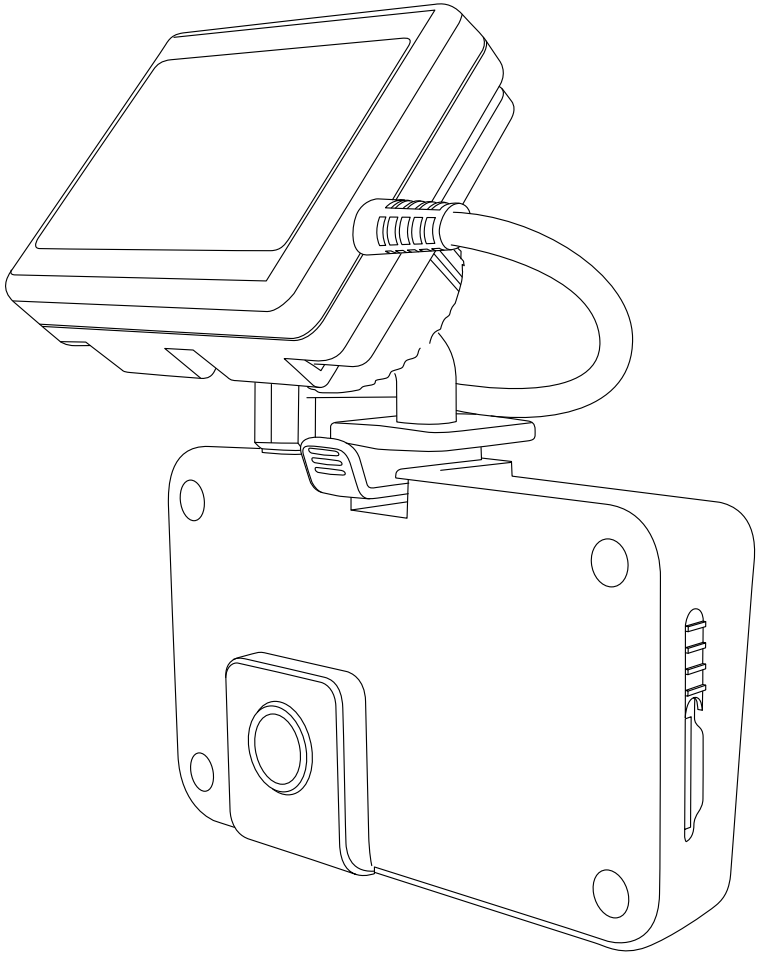

# EDR-101 Event Data Recorder

## Instruction manual



# CONTENTS

	PAGE
<b>1. General instructions</b> .....	<b>3</b>
<b>2. Features &amp; box contents</b> .....	<b>4</b>
<b>3. Components and functions</b> .....	<b>5</b>
<b>4. Installing the recorder in your vehicle</b> .....	<b>6</b>
1) Recommended installation location .....	6
2) Mounting the GPS antenna .....	7
3) Mounting the recorder .....	7
<b>5. Preparations for operation</b> .....	<b>8</b>
1) Inserting the micro SD card .....	8
2) Removing the micro SD card .....	8
<b>6. Operation - System active</b> .....	<b>9</b>
1) Power ON/OFF .....	9
2) Checking GPS .....	9
<b>6. Operation - Recording modes</b> .....	<b>10</b>
1) Video recording .....	10
2) Infinite recording .....	10
3) Event recording .....	10
4) Emergency recording .....	11
5) Parking mode .....	11
6) Audio recording ON/OFF .....	11
<b>6. Operation - Auxiliary display</b> .....	<b>12</b>
1) Real-time displaying .....	12
2) System restart .....	12
<b>7. PC Viewer Manager</b> .....	<b>13</b>
1) How to install & use PC Viewer Manager .....	13
2) Configuration settings .....	17
3) Memory info .....	18
4) Version info .....	18
<b>8. Firmware Update</b> .....	<b>19</b>
<b>9. Micro SD Card data</b> .....	<b>19</b>
<b>10. Maintenance</b> .....	<b>19</b>
<b>11. Specifications</b> .....	<b>20</b>
• Built-in camera .....	20
• G-Sensor values.....	20
• Micro SD Card capacities .....	21
• External camera specification .....	22
<b>12. Disclaimer</b> .....	<b>23</b>

## CAUTION

Thoroughly read and understand the information in this manual before installing or operating the product.

This product should be installed by a qualified professional installer.

Do not shock the product, this may cause malfunctions.

Do not expose the product to high temperatures or humidity.

- It may cause electric shock or malfunctions.

The windscreen and camera lens should be kept clean, if it is dirty the recording image quality could be poor.

## GPS

It may take up to 10 minutes after power is connected to get GPS reception. It may take longer to locate your position when the vehicle is moving compared to when the vehicle is stationary.

GPS reception may be reduced:

- If there is metallic tinting on the windscreen.
- If objects are positioned around the GPS antenna.
- If magnetic devices are positioned close to the GPS antenna.
- On heavily overcast or cloudy days.
- In built-up areas.

During changing levels of brightness such as entering/exiting a tunnel the image quality can be poor until the recorder adjusts to the new ambient light level.

## WARNING

Always check that data saves on the micro SD card correctly.

Brigade does not take any responsibility for data loss.

Ensure the micro SD Card is fully inserted.

Before ejecting the micro SD Card, please ensure the power is off. If you eject the micro SD Card while powered, it may cause malfunction or data loss.

There are no user-serviceable parts inside. Disassembly may cause permanent damage.

If you find any data loss, please replace the micro SD Card.

Please check the capability of the micro SD Card when you purchase spare micro SD Cards. The SD card must be a minimum of Class 10.

The built-in battery is to ensure the last recording is saved to the Micro SD card when the power is removed. The main power supply is used for normal recording.

The built-in battery has a limited lifespan, so the recording time may reduce over time. (The life time is different depending on usage conditions).

If you find that the last recording is not saved, the battery may have reached the end of its life.

## 2 Features

- Records accidents
- Parking mode function
- Wide angle of view of 120° built-in 2.0M Pixel CMOS CAMERA
- Audio recording
- Audible alerts
- GPS
- Built-in G-SENSOR (Front/Rear, Left/Right, Up/Down shock sensing)
- Micro SD Card (Max 32GB)
  - If the recording exceeds the micro SD Card capacity, it deletes recordings starting with the oldest file and records continuously.
- Built-in battery back-up
- 12V~24Vdc
- Supports External Camera (see page 22)

## 1 Box contents

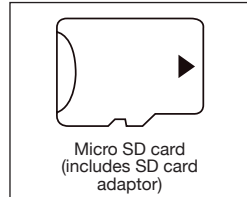
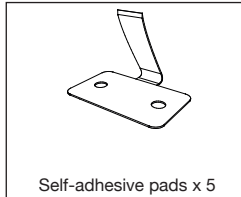
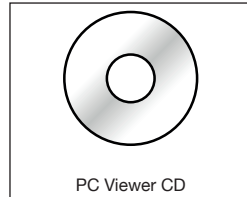
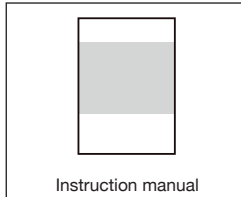
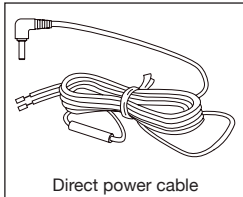
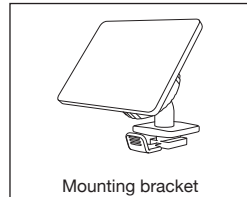
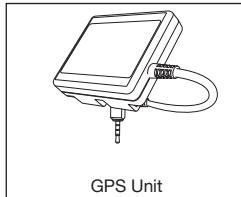
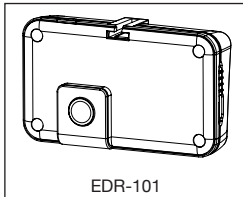

## 2 Optional parts

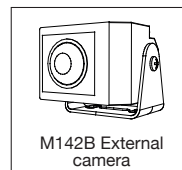
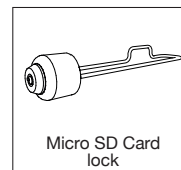
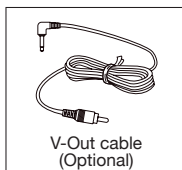
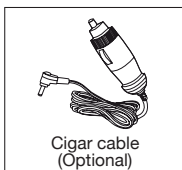

- Pictures of the products may differ from the actual product. Some parts may change without notification. Contact Brigade for details.

## Components and functions 3

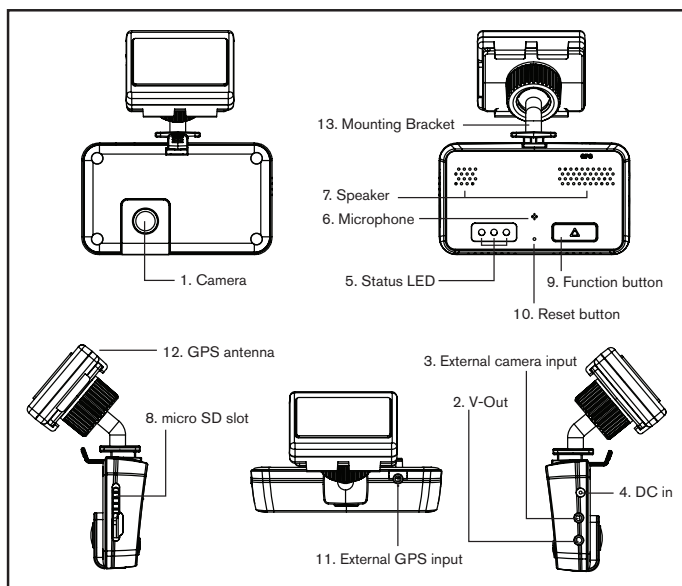

1. Camera	2.0M Pixel CMOS CAMERA
2. V-OUT	Video output connection
3. CAM (Input)	External Camera input connection
4. DC IN (Power Input)	Connects the power cable (DC 12V~24V)
5. Status LED	Power & GPS/Recording/Audio Status indication
6. Microphone	Audio recording microphone
7. Speaker	Output speaker for audible warnings
8. Micro SD Card Slot	A slot for inserting the micro SD Card
9. Function Button	Emergency recording, Audio recording ON/OFF
10. Reset Button	System reset button
11. GPS Input	GPS signal input connection
12. GPS antenna	
13. Mounting Bracket	

### 3 Power connections

\*Connect the red wire to a 12-24V supply (ensure supply circuit is fused).

Connect the black wire to a suitable vehicle ground.

Connect the DC Jack to the DC connection of the recorder.

There is an optional cigar lighter power cable available to power the recorder from a vehicle cigar lighter socket.

\*If you connect to a permanent supply be aware that the vehicle battery may become discharged over time.

## 4 Installing the recorder in your vehicle

### 4 Recommended installation location

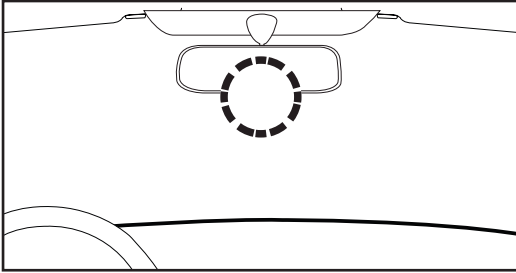

The optimum position for the recorder is in the centre of the windscreen.

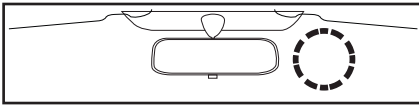
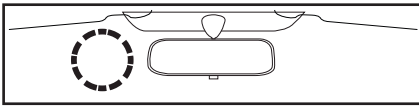

If it is difficult to position the recorder in the centre of the windscreen, the recorder may be positioned to one side but this will compromise the recorded view. Make a test recording to help optimise the position.

**Please ensure all regulations/legislation are adhered to when installing the product.**

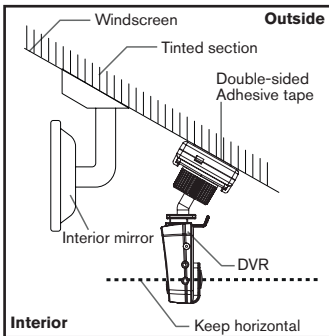

Car

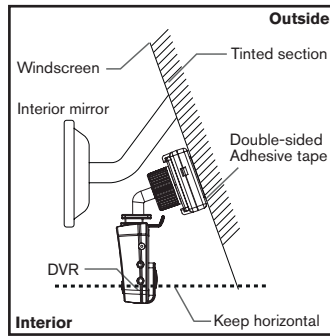

Commercial vehicle

- Position the recorder so it does not obstruct the driver's view and that there are no obstructions in the camera view, including any windscreen tint.
- Position the recorder with the camera vertical, i.e. looking directly forward through the windscreen.

## Installing the recorder in your vehicle **4**

Always refer to the vehicle manufacturer's guidelines for installation and connections to the vehicle.

- Disconnect the vehicle battery.
- Follow safe working practices.

Ensure the product is attached to the windscreen properly.

- Clean the windscreen and adhere the product firmly, otherwise it may become detached due to temperature/humidity/dust/shock/vibration.

### **5** Mounting the GPS antenna

---

1. Clean the windscreen.
2. Stick the GPS to the screen (using supplied self-adhesive pad).

### **6** Mounting the recorder

---

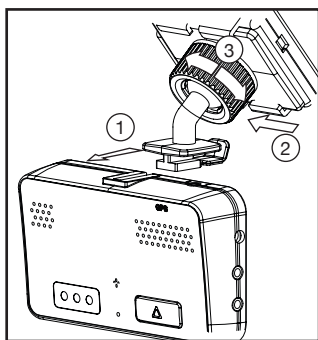

- 1 Slide the mounting bracket into the front of the receiving channel until the retaining lug latches in.
- 2 Slide the mounting bracket into the retainers on the rear of the GPS antenna.
- 3 Loosen the locking wheel.
- 4 Adjust the angle of the recorder.
- 5 Tighten the locking wheel to lock the angle of the bracket.

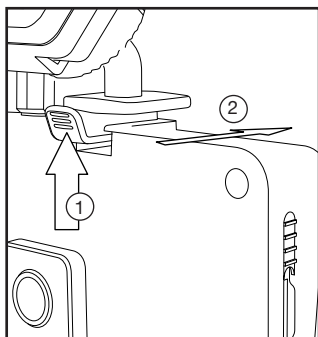

To remove the recorder from the mounting bracket:

- 1 Apply light pressure to the release tab until the retaining lug un-latches.
- 2 Slide the recorder off the bracket.

## 5 Preparations for operation

To remove the micro SD Card, first turn off the power and check the Power & GPS LED is off (no more than 20 sec. required). Then, remove the micro SD Card. If you remove the micro SD Card with the power on, a warning chime sounds and no recordings will be saved. (It may also cause loss of data and damage to micro SD Card).

## 7 Inserting the micro SD Card

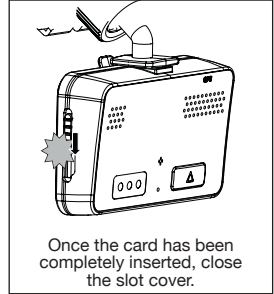
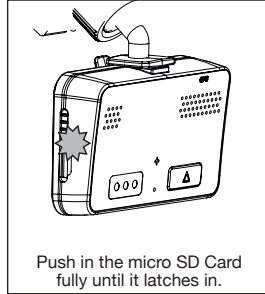
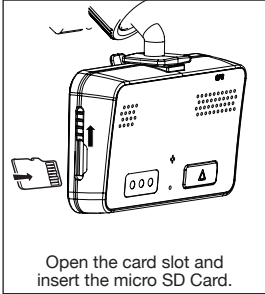

## 8 Removing the micro SD Card

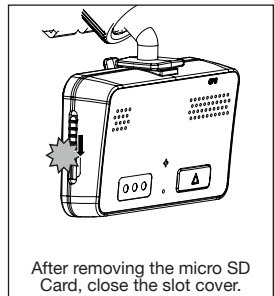
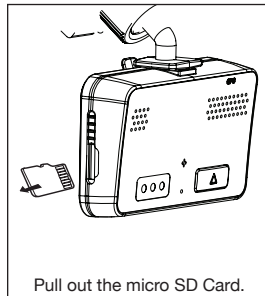
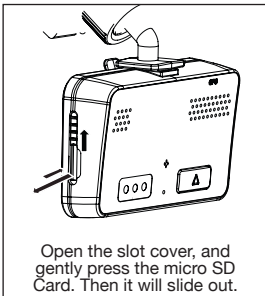

Be sure that the micro SD Card inserts into the micro SD Card slot correctly. If not this will cause an error and could damage the micro SD Card or recorder.

 Do not operate whilst driving.

## 9 Power ON / OFF

To power on, turn the vehicle ignition on with the power cable connected, the 3 LEDs will illuminate. When the recorder has finished starting up, a chime will sound and the Power/GPS LEDs will illuminate red.

2. If the vehicle ignition is turned off, the recorder will remain on for up to 10 seconds in order to save the last recording file and then turn off with a chime sounding.

The product does not power off by itself after the vehicle ignition is switched off when it is connected to permanent power supply. If you want to power off, please disconnect the power cable from product.

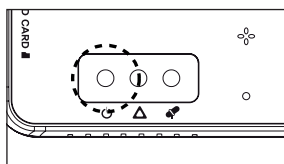

- Power ON: RED LED
- Power OFF: LED off

## 10 Checking GPS

When the recorder is powered up it will start searching for GPS signals. When the recorder has located its position the Power & GPS LED will illuminate green and a chime will sound.

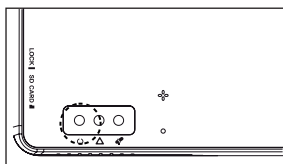

The GPS function can be used to estimate the driving route and speed.

- With the GPS reception: Green LED
- Without the GPS reception: Red LED

## 6 Operation - Recording modes

### 11 Video recording

Once the installation is complete, turn on the vehicle ignition. The recording will start when the recorder has finished starting up.

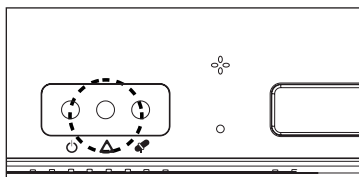

#### LED operation.

**Infinite recording:** Blue LED flashes at intervals of 2.5 seconds.

**Event recording:** Blue LED flashes at intervals of 0.5 second.

### 12 Infinite recording

When there are no events, it continues recording at intervals of 1 min.

1 min.

1 min.

1 min.

1 min.

1 min.

Continued...

### 13 Event recording

It performs recording 10 seconds before and 10 seconds after an event (20 seconds in total).

10 sec. before an event

EVENT

10 sec. after an event

- When the recorder is configured to **Infinite** and **Event** mode, any event (impact) that is detected during normal recording, normal recording will stop and event recording will start. After event recording, normal recording will resume.

**Example:** If an event happens 1 minute and 50 seconds after starting recording:

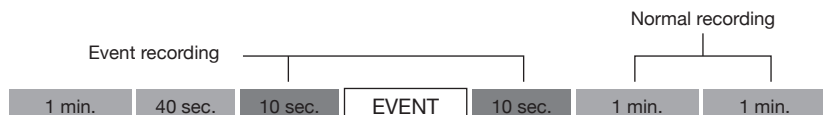

Save as a normal recording file. (1 min).

The portion up to 10 seconds before the event from 1 minute to 1 minute and 40 seconds will be saved as a file of normal recording (40 seconds).

- **'Event'** is when any shock or impact is detected. The higher the sensitivity, the finer the shock or impact will be detected. The lower the sensitivity, the stronger the shock or impact will be detected. It is possible to adjust the sensitivity of the detection in the **PC VIEWER MANAGER** (refer to page 13).

When the recorder is set to **Infinite** and **Event** recording, the micro SD card separates the storage space approximately 60% for Infinite 40% for Event.

When the recording is over the micro SD Card capacity, it overwrites the recordings starting with the oldest one first.

## 6 Operation - Recording modes

### 14 Emergency recording

Emergency recording function is intended to record any unexpected events or when it is deemed necessary by the driver. Such images will be saved in the **EVENT** folder of the micro SD Card.

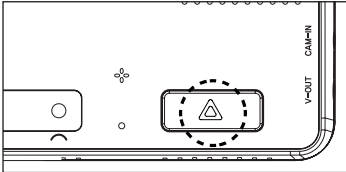

Briefly press down Function button [△], manual recording will be enabled. Recording procedures are same as those for event recording (10 seconds before/ 10 seconds after pressing the button).

**This function will be disabled during Event recording or if the recorder is set to Infinite recording only.**

### 15 Parking mode

If there is no movement or vibration for 10 minutes on **Infinite** recording mode, the recorder will enter **Parking** mode automatically (when recorder is powered).

When a shock or vibration is detected it will create a recording 10 sec. before and 10 sec. after the event.

LED for Parking mode

\* Parking mode: ON

Stand by – Power/GPS LED (Red) / Rec LED (Blue) / Audio LED (Light Green) scrolls every 0.5 seconds

Event – Rec LED (Blue) blinks

\* Parking mode: OFF

Same as normal mode

### 16 Audio recording ON/OFF

• Audio recording ON/OFF (Default : OFF)

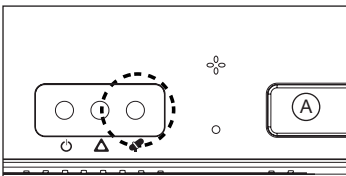

While using the product, press Function button [△] for approximately 20 seconds.

Then the Audio recording is on/off.

\* Audio recording ON: Light Green LED ON

\* Audio recording OFF: Light Green LED OFF

## 6 Operation - Auxiliary display

### 17 Real-time displaying

By using V-OUT mode (optional) you can watch the real time recording (front view only) when the v-out cable is connected to a monitor.

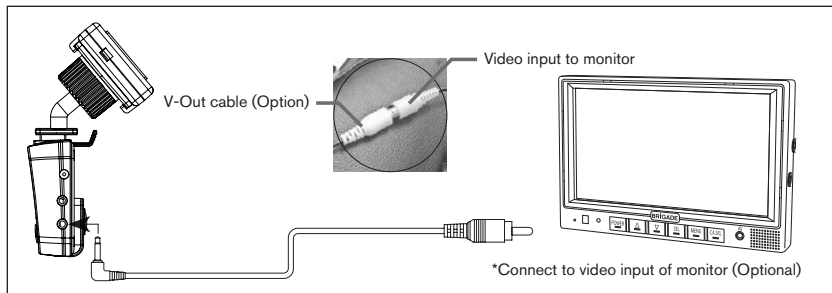

\* Additional adaptor cables may be required. If any non Brigade cable is used, the unit may malfunction.

### 18 Restart

System reset function is used in the event of any fault(s) during operation or when the recorder stops suddenly.

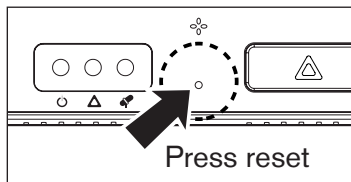

Using a thin object gently press down the RESET button. The recorder will be reset and will restart.

## 19 How to use PC VIEWER MANAGER

Copy the PC Viewer program from the CD to your PC.



Once copied, double click on  icon to run the PC Viewer Programme.









- |                                |  |
|--------------------------------|--|
| ① Playback display             | Shows front camera video   |
| ② Playback display             | Shows rear camera video  |
| ③ G-SENSOR/Playback Location   | Shows G-SENSOR data with graphs and playback location  |
| ④ Speedometer                  | Displays GPS speed   |
| ⑤ Playback Control             | Adjusts speed of playback  |
| ⑥ Viewer Control               | Stop/Previous file /Rewind/Play(Pause) / Forward / Next file   |
| ⑦ Volume Control               | Controls the play volume. (Mute/Volume +,-)  |
| ⑧ GPS Information              | The GPS location data is shown through this map. (Data / Time / Speed / Location / Direction)                          |
| ⑨ File Management              | File open / Save / Delete  |
| ⑩ Playback List                | Shows playback list  |
| ⑪ Map Information (Google map) | The driving routes are shown through this map. This function is only possible when an internet connection is available |
| ⑫ Screen Capture               | Saves the playback screen as Jpeg file   |
| ⑬ Configuration Set            | Adjusts settings for the system configuration  |
| ⑭ Programme Exit/Minimization  | Exits the PC Viewer program or Minimizes the PC Viewer program   |

## 7 PC Viewer Manager

### • Menu Button and Control

Button	Function	Description
	Volume control	Controls the play volume (Mute / Volume +,-)
	Play/Pause	Play or pause the playing file
	Back/Next	Play previous or next file

### • Playback list button controls

Button	Function	Description
	All Files	Shows all files in the list
	Normal Files	Shows normal files only in the list
	Event Files	Shows event files only in the list
	Open Folder	Selects the folder to play
	File Save	Save the selected file to hard disk drive
	File delete	Delete the selected file from micro SD Card

### 1 Open folder

- 1) Click on  button.
- 2) When the explorer appears, select the video files.
- 3) You can select one file or all files (CTRL+A).

• Playback list

FILE TYPE >	ALL	NORMAL	EVENT	PARKING
<input type="radio"/>	TYPE	DATE	FILE NAME	
<input type="radio"/>	ALL	2011.10.28, 13:02:28	111028_130228_020_I_1.mp4	
<input type="radio"/>	ALL	2011.10.28, 13:02:28	111028_130229_020_I_2.mp4	
<input type="radio"/>	ALL	2011.10.28, 13:03:26	111028_130327_002_E_1.mp4	
<input type="radio"/>	ALL	2011.10.28, 13:03:26	111028_130327_002_E_2.mp4	
<input type="radio"/>	ALL	2011.10.28, 13:03:42	111028_130343_003_E_1.mp4	
<input type="radio"/>	ALL	2011.10.28, 13:03:44	111028_130343_003_E_2.mp4	
<input checked="" type="radio"/>	ALL	2011.10.28, 13:04:08	111028_130409_021_I_1.mp4	
<input type="radio"/>	ALL	2011.10.28, 13:04:10	111028_130409_021_I_2.mp4	
<input type="radio"/>	ALL	2011.10.28, 13:06:08	111028_130608_022_I_1.mp4	
<input type="radio"/>	ALL	2011.10.28, 13:06:10	111028_130609_022_I_2.mp4	

Function	Description
① File list	Shows file on the micro SD Card
② File Select	Select the file/s to save or delete.
③ File Type	Select files to be displayed ALL/EVENT/INFINITE

- Files are arranged by Date/Time.
- Files can be arranged by ALL / NORMAL / EVENT / PARKING
- There is a select button to the left of each file.
- When the select button is clicked, the file will be selected or cancelled. (Multiple selection)
- When the select button on the top is clicked, all of the files will be selected or cancelled.

## 2 File Save (Save to hard disk drive)

- Select the files that you want to save to a hard disk drive. (Multiple selection possible)
- Click the  **SAVE** button, then select the folder on the PC to which you want the files saved.



## 3 File Delete

- Select the files that you want to delete. (Multiple selection).
- Click the  **DELETE** button, the selected files will be deleted from the micro SD Card.

\*\* Caution: Files not saved to the hard disk drive cannot be recovered.



## 7 PC Viewer Manager

### • Google Map Button

Control Button	Function
	Map Tracking Google Maps can be displayed when user's PC is connected to the internet
	Map Zoom IN/OUT

# Google Map can be displayed when user PC is connected through the internet.

### Other buttons

Button	Function	Description
	Configuration set	Settings can be configured
	Minimise/Close window	Exit or Minimise the PC Viewer program

## 20 Configuration settings

When the Configuration Set button is selected , the Settings window as shown below opens.

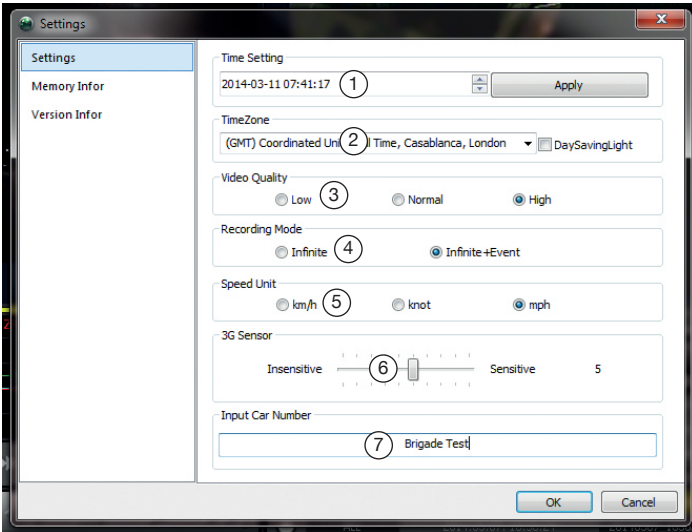

Function	Description
① Date/Time	Choose the current date and time
② Standard time	Select the standard time zone (summer time) daylight saving
③ Video Quality	Set up the video quality (default : HIGH 1280 x 720p)
④ Recording Mode	Select the recording mode. ( default : infinite mode + event mode)
⑤ Speed Unit	Select the speed unit
⑥ 3G-SENSOR	Adjust the sensitivity levels
⑦ Input car number	Register a vehicle number and it will be shown in playback

- Apply button: Apply time setting to recorder (a \_time\_INI.cfg file will be created on the micro SD Card).
- After time settings are loaded to the recorder the files will be deleted automatically.

# 7 PC Viewer Manager

## 3 Memory Info

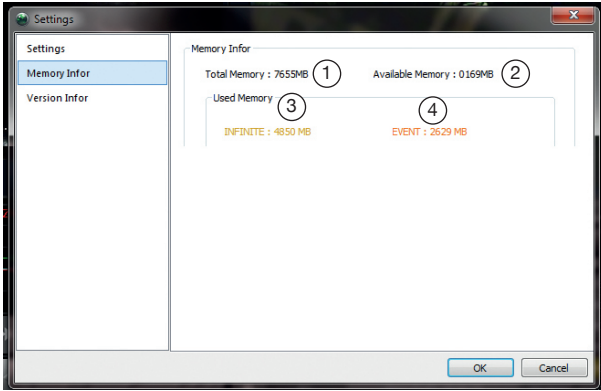

Function	Description
① Total Memory	Shows Micro SD Card capacity
② Available Memory	Shows available memory on Micro SD Card
③ Infinite Memory	Shows memory used for Infinite recordings
④ Event Memory	Shows memory used for Event recordings

## 21 Version Info

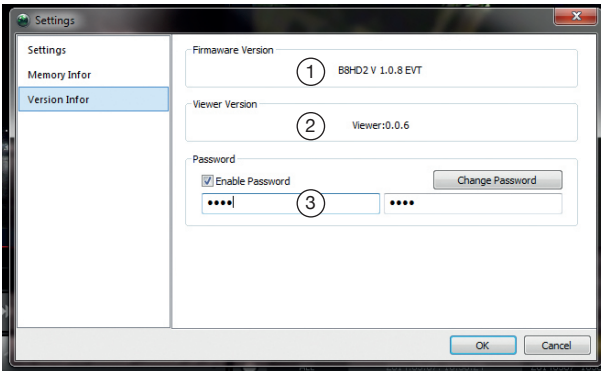

Function	Description
① Firmware version	Shows the Firmware version of the recorder
② Version Info	Shows the version of PC Viewer and recorder Firmware version.
③ Input User Password	Register user password and check the "Apply to user password" Check the "Change password" to record the registered password.

### Firmware upgradeable through micro SD Card.

- 1) Copy the target file to update, 'bin' file into a root folder of micro SD Card.
- 2) Insert the micro SD Card into the product and connect the power.
- 3) The updating process is in progress when the Red LED blinks rapidly.
- 4) When **Update** is completed, the recorder will automatically reboot.
- 5) Power off and on the recorder, the Product is now working based on the new firmware.

## Micro SD Card data 9

### 1. Event folder

In Event Record Mode, the product records a maximum 20 seconds of video & audio and saves it with the following name format "yymmdd\_hhmmss\_xxx\_E\_x.mp4" in this folder.

In Emergency Record Mode, the product records a maximum 20 seconds of video & audio and saves it with the following name format "yymmdd\_hhmmss\_xxx\_B\_x.mp4" in this folder.

### 2. Infinite Folder

In Normal Record Mode, the product records video & audio and saves it with the following name format "yymmdd\_hhmmss\_xxx\_I\_x.mp4" in this folder.

In the Parking Record Mode, product records video & audio and saves it with the following name format "yymmdd\_hhmmss\_xxx\_P\_x.mp4" in this folder.

### 3. \_System.cfg

The product saves in this folder the configuration of the recorder (when Micro SD Card is inserted into a powered recorder) or the configuration created in the PC Viewer.

### 4. Version.txt

Displays the recorder's firmware version information as a text file.

### 5. \_HME\_INI.cfg

The product saves in this folder the time settings from the PC Viewer manager software. (This will automatically delete when loaded to the recorder).

## Maintenance 10

To maintain the performance of this product it is recommended that the SD card be formatted once every 3-6 months based on an 8GB SD card. The regularity of this maintenance is dependent on the SD card, settings and user scenarios.

If less frequent SD card maintenance is required then you are able to source additional SD cards. These are commonly available on the market. The alternative options are as follows:

1. A larger capacity SD card up to 32GB. Time between recording cycles is reduced due to larger capacity SD card.
2. A higher specification SLC (Single Level Cell) SD card, able to withstand more recording cycles.

(Note: Brigade Electronics does not currently supply the above alternatives)

# 11 Specifications

Built-in Camera	112° Viewing Angle
Max Recording Resolution	Built-in camera: 1280x720: Auxiliary camera 640x480
Recording Frame	1CH : 30fps, 2CH : 17fps / 13fps
Video Compression	H. 264 MPEG4
Recording Modes	INFINITE / EVENT / PARKING / EMERGENCY
Operating Voltage	12V-24Vdc
Operating Temperature	-10°C ~ 60°C
Storage Temperature	-20°C ~ 70°C
Dimension	85(W)mm X 50(H)mm X 24(D)mm (Body only)
Weight	60g (Recorder only)
Current Consumption	Max 260mA@12V (Without auxiliary camera)
Operating voltage	12-24Vdc
Video output	1VP-P 75Ω NTSC
SD Card	Micro SD Class 6 - Max size 32Gb

## 1. G-Sensor Value to operate Event mode (Values in G)

	Level 9	Level 8	Level 7	Level 6	Level 5	Level 4	Level 3	Level 2	Level 1	Level 0	AXIS
Front/ Back	1.31	1.25	1.18	1.12	1.06	1.0	0.93	0.87	0.81	0.75	x
Left/ Right	1.37	1.31	1.25	1.18	1.12	1.06	1.0	0.93	0.87	0.81	y
Up/Down	1.40	1.34	1.28	1.21	1.15	1.12	1.06	1.0	0.93	0.84	z

## 2. G-Sensor value for enabling Parking Mode.

When the G-Sensor value stays under 0.08G for 10 minutes, Parking Mode will be enabled.

## 3. G-Sensor value for disabling Parking Mode.

When the G-Sensor value stays above 0.08G for more than 4 seconds, Parking Mode will be disabled.

## 4. G-Sensor value for starting Parking Mode recordings.

When the G-Sensor value exceeds 0.08G.

## Micro SD Card capacities

### EDR-101 single camera

Video quality			Infinite Memory	Event Memory	Extra Memory*	Total
	Card Size (Gb)	File size per min (MB)	Recording Time (Min)	Recording Time (Min)	Extra (Min)	TOTAL TIME (Min)
HIGH	4	45	58.7	18.9	5.6	83.1
	8	45	128.4	32.2	5.6	166.2
	16	45	214.7	112.2	5.6	332.4
	32	45	440.4	218.9	5.6	664.9
NORMAL	4	37.5	70.4	22.7	6.7	99.7
	8	37.5	154.1	38.7	6.7	199.5
	16	37.5	257.6	134.7	6.7	398.9
	32	37.5	528.5	262.7	6.7	797.9
LOW	4	30	88.0	28.3	8.3	124.7
	8	30	192.7	48.3	8.3	249.3
	16	30	322.0	168.3	8.3	498.7
	32	30	660.7	328.3	8.3	997.3

### EDR-101 with external camera

Video quality			Infinite Memory	Event Memory	Extra Memory*	Total
	Memory (Gb)	File size per min (MB)	Recording Time (Min)	Recording Time (Min)	Extra (Min)	TOTAL TIME (Min)
HIGH	4	47	56.2	18.1	5.3	79.6
	8	47	123.0	30.9	5.3	159.1
	16	47	205.5	107.4	5.3	318.3
	32	47	421.7	209.6	5.3	636.6
NORMAL	4	39	67.7	21.8	6.4	95.9
	8	39	148.2	37.2	6.4	191.8
	16	39	247.7	129.5	6.4	383.6
	32	39	508.2	252.6	6.4	767.2
LOW	4	32	82.5	26.6	7.8	116.9
	8	32	180.6	45.3	7.8	233.8
	16	32	301.9	157.8	7.8	467.5
	32	32	619.4	307.8	7.8	935.0

\* Extra Memory is reserved by the recorder to replace damaged portions of the Micro SD Card should a fault occur. It is not used to write data to.

## 11 External camera specification

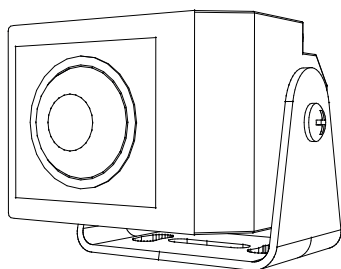

Camera	EDR-142C CCD Colour Camera
Viewing angle	140° Wide Viewing Angle
Dimensions	38.5(W) X 29.5(H) X 38(D)
Resolution	420TV Lines
IP Rating	IPx8
Colour	Black painted finish
View	Normal
Weight	125g
Cable length	5m

Specification subject to change without notice.

### **Disclaimer**

Camera monitor systems are an invaluable driver aid but do not exempt the driver from taking every normal precaution when conducting a manoeuvre. No liability arising out of the use or failure of the product can in any way be attached to Brigade or to the distributor.

Specifications subject to change.



[www.brigade-electronics.com](http://www.brigade-electronics.com)

